

# MIG/MAG welding torch system "ROBO WH & WH-PP" liquid cooled



## Quick adaptation to changing welding tasks ...

The liquid cooled MIG/MAG neck change welding torch system WH / WH-PP enables the complete torch neck to be replaced either manually or automatically – thanks to the innovative interface technology on the change body. This means torches of the same design can be replaced in seconds for maintenance purposes, or torches with special geometries for different welding positions can be changed as required.

Equally, the replacement of contact tip and gas nozzle and the monitoring of the TCP also takes place outside of the welding cell, thus increasing the availability of the system and reducing downtimes.

## Advantages that speak for themselves:

- Fast torch neck change and replacement of wear parts increase system availability
- Flexible adaptation to changing welding tasks
- Also available as a push-pull system for precise wire feeding
- Liquid cooled up to 600 A

up to  
550 A



## Degree of automation:

Low	Medium	High
-----	--------	------

## Typical areas of application:



- Automotive construction
- Automotive suppliers (Tier 1, Tier 2)
- Commercial vehicle construction
- Earth-moving equipment
- Rail vehicle construction
- Machine and steel construction

## Material:

- Construction steels (coated / non-coated)
- Chrome-nickel steels
- Duplex steels
- Nickel basic materials
- Mixed compounds
- Aluminium materials
- Magnesium materials
- Copper materials
- Special materials

## Robot interface:

- Conventional robot  
(Cable assembly external):
  - Robot mount CAT3
  - Fixed bracket RTM
- Hollow wrist robot  
(Cable assembly internal):
  - Robot mount iCAT
  - Bracket iSTM (for robots with integrated collision software)
- Hollow wrist robot  
(Cable assembly external):
  - Robot mount CAT3
  - Fixed bracket RTM

## \* Definition of the degree of automation:

- Low = Torch neck change not possible
- Medium = Torch neck change possible (manually)
- High = Torch neck change possible (manually & automatically)

# “ROBO WH & WH-PP” liquid cooled System Overview & Technical Data

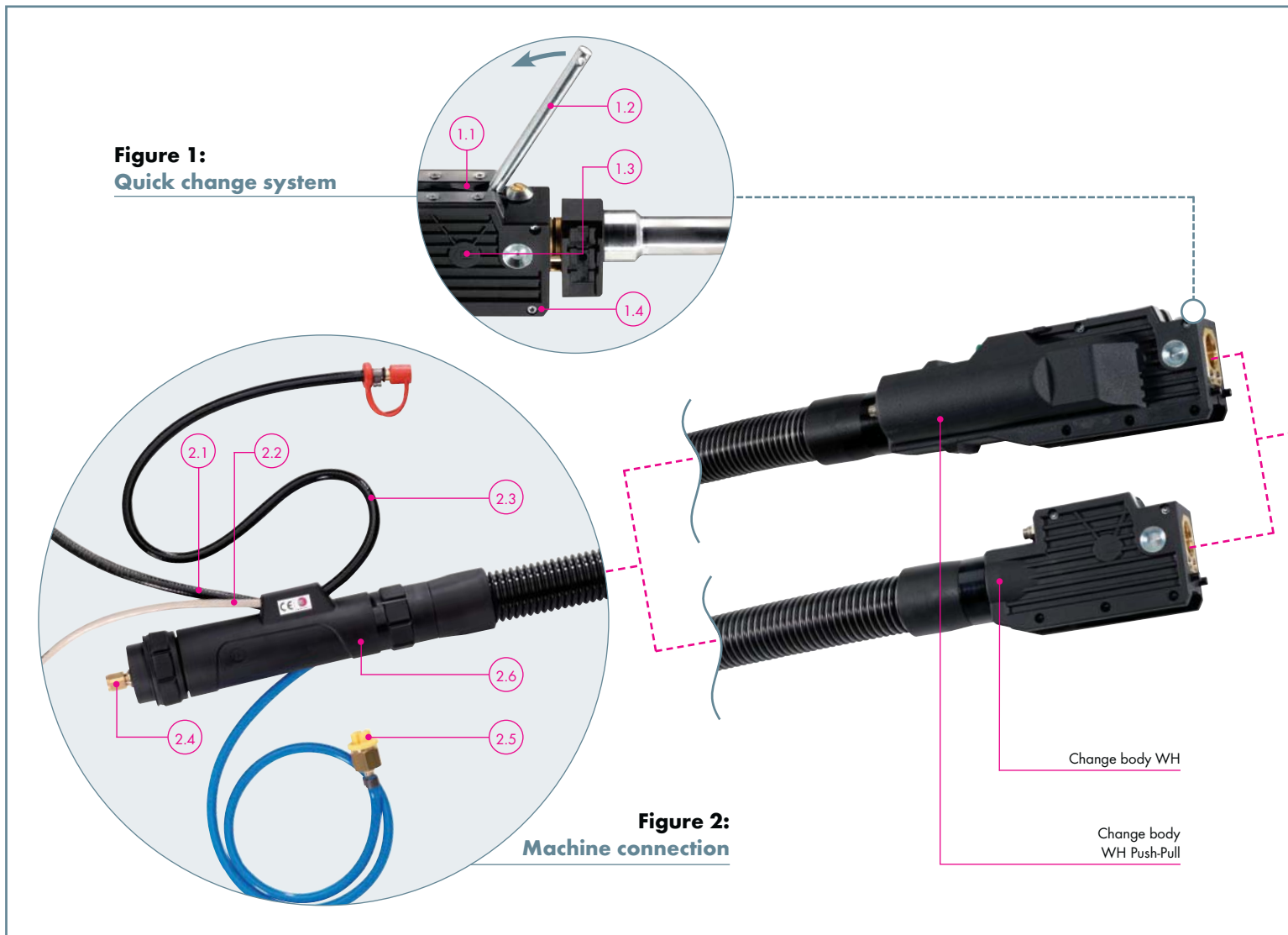

**Figure 1:**  
Quick change system

- 1.1 Rubber seals prevent dust/spatter penetration
- 1.2 Tool for manual torch neck replacement (hand lever)
- 1.3 Integrated wire-cutting and location function for torch neck replacement
- 1.4 Sturdy housing for change body (optionally with wire brake<sup>1</sup>)

**Figure 2:**  
Machine connection

- 2.1 Coolant feed hose with closure
- 2.2 High-grade control cable with strain relief
- 2.3 Coolant return hose with closure
- 2.4 Machine connection available for all standard wire feeds
- 2.5 Airblast hose with blanking plug
- 2.6 Sturdy casing with bend-protection spring

<sup>1</sup> Wire brake and gas nozzle sensor connection are required for tactile component location. Ask your robot manufacturer for more details.

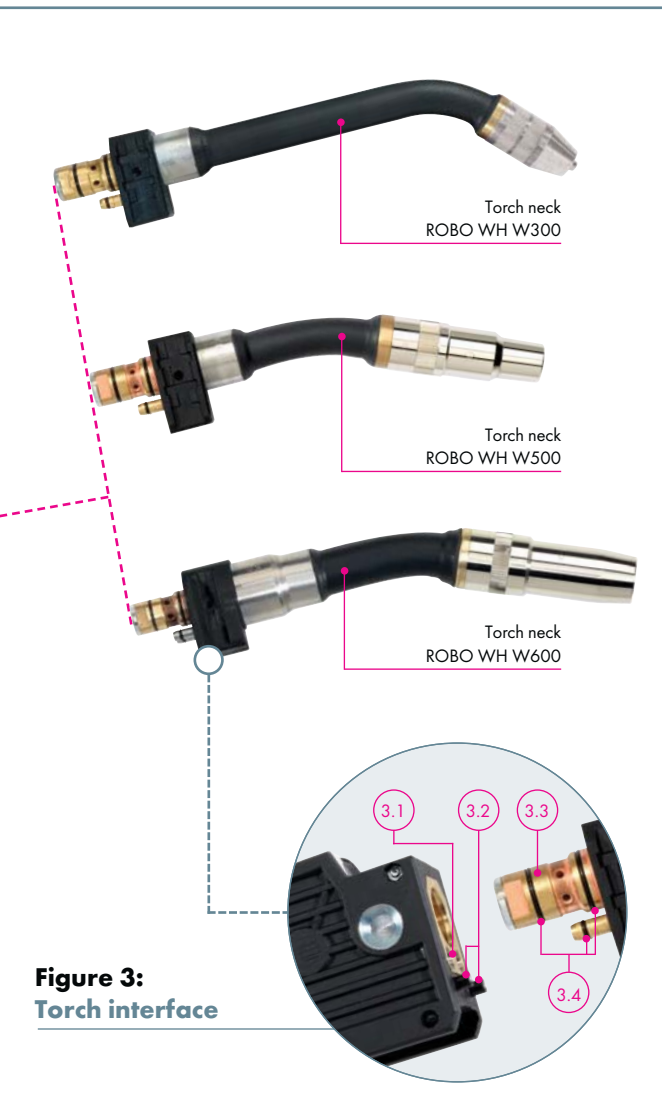

**Figure 3:**  
**Torch interface**

**Figure 3:**  
**Torch interface**

- 3.1 Non-return valves for leak-free torch neck replacement
- 3.2 Contacts for optional gas nozzle sensor<sup>1</sup>
- 3.3 Compact and space-saving interface
- 3.4 O-rings ensure a coolant and gas-tight connection

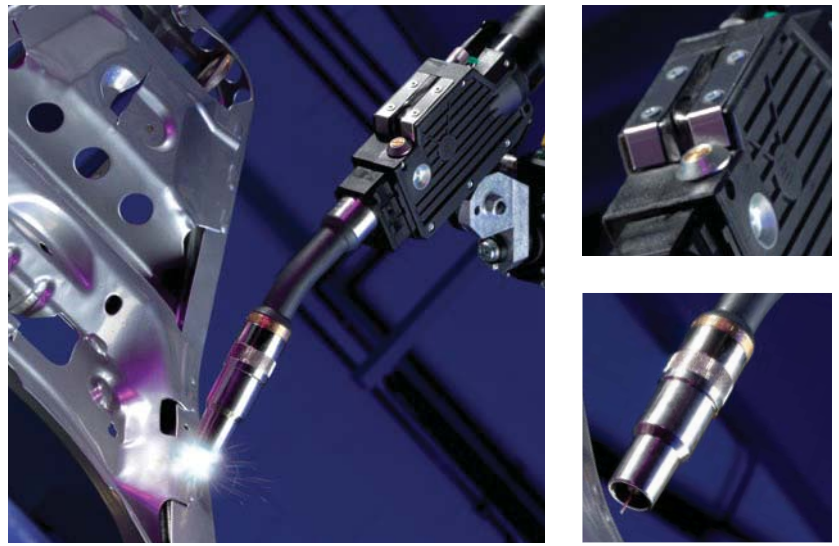

**Technical data (EN 60 974-7):**

**ROBO WH W300**

Type of cooling: liquid cooled  
 Rating: 330 A CO<sub>2</sub>  
 300 A Mixed gases M21 (EN ISO 14175)  
 Duty cycle: 100 %  
 Wire-Ø: 0.8 - 1.2 mm  
 Torch geometries: 45°

**ROBO WH W500**

Type of cooling: liquid cooled  
 Rating: 550 A CO<sub>2</sub>  
 500 A Mixed gases M21 (EN ISO 14175)  
 Duty cycle: 100 %  
 Wire-Ø: 0.8 - 1.6 mm  
 Torch geometries: 0°/22°/35°/45°

**ROBO WH W600**

Type of cooling: liquid cooled  
 Rating: 600 A CO<sub>2</sub>  
 550 A Mixed gases M21 (EN ISO 14175)  
 Duty cycle: 100 %  
 Wire-Ø: max. 1.6 mm  
 Torch geometries: 0°/22°/35°/45°

**Note on the technical data:**

Rating data were determined under normal conditions at low to medium reflected heat, free air circulation and at 28°C ambient temperature. When used under more difficult conditions, the rating data must be reduced by 10 - 20 %. The rating data are reduced by up to 35 % for pulse arc welding.

# "ROBO WH & WH-PP" liquid cooled Torch Necks & Wear Parts

## ROBO WH W300



### Torch neck

Features	Part-No.
Standard	962.1889.1

Wear parts and fittings are not included in the scope of delivery! Please order these separately and according to the application!

### Neck liner

for	Wire-Ø	Part-No.
Steel	Ø 0.8-1.2	149.0040.5
Aluminium	Ø 0.8-1.2	149.0014.5

## Wear parts for ROBO WH W300

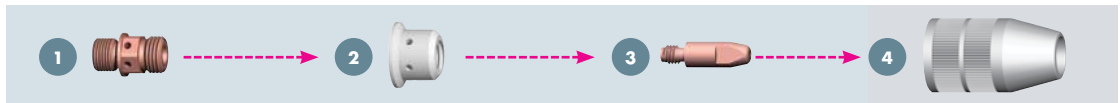

### 1 Contact tip holder (10 pcs.)

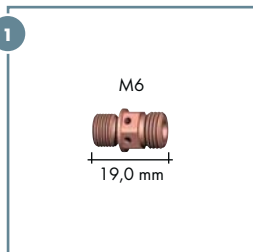

Type	Part-No.
M6 Copper <sup>1</sup>	785.5052

<sup>1</sup> Recommended for high amperages.

### 2 Gas diffuser (10 pcs.)

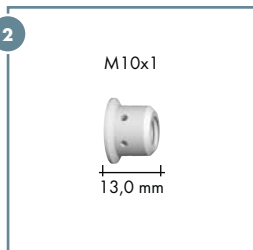

Type	Part-No.
Standard	962.0657
High temperature resistant (ceramic)	962.1341

### 3 Contact tip (10 pcs.)

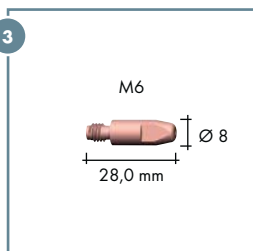

Type	Wire-Ø	Part-No.
CuCrZr	Ø 0.8	140.0054
	Ø 0.9	140.0172
	Ø 1.0	140.0245
	Ø 1.2	140.0382

### 4 Gas nozzle (10 pcs.)

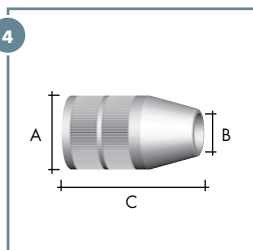

Type conical	Ø A	Ø B	Length C	Part-No.
Recess (-1.0 mm) <sup>2</sup>	Ø 25.0	Ø 13.0	48.5 mm	145.0564
Stick-out (+3.0 mm) <sup>3</sup>	Ø 25.0	Ø 13.0	44.5 mm	145.0495.10
Stick-out (+3.0 mm) <sup>3</sup>	Ø 25.0	Ø 15.5	44.5 mm	145.0494.10

<sup>2</sup> Recess: Contact tip recessed

<sup>3</sup> Stick-out: Contact tip protruding

# "ROBO WH & WH-PP" liquid cooled Torch Necks & Wear Parts

## ROBO WH W500

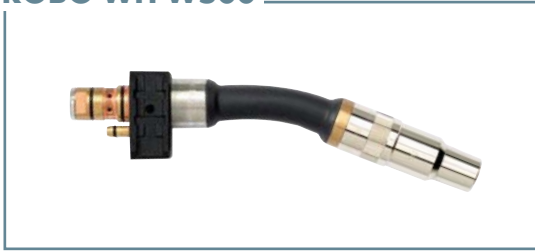

### Torch neck

Features	Part-No.			
	0°	22°	35°	45°
Standard	962.1550.1	962.1549.1	962.1551.1	962.1532.1
with gas nozzle sensor*	962.1595.1	962.1596.1	962.1597.1	962.1598.1

Wear parts and fittings are not included in the scope of delivery! Please order these separately and according to the application!  
\* Gas nozzle sensor connection for tactile seam location via gas nozzle

### Neck liner

Torch geometry	Wire-Ø	Part-No.	
		for steel	for aluminium
0° / 22°	Ø 0.8-1.0	-	149.0230.5
	Ø 1.0-1.2	149.0226.5	149.0232.5
	Ø 1.4-1.6	149.0228.5	-
35° / 45°	Ø 0.8-1.0	-	149.0231.5
	Ø 1.0-1.2	149.0227.5	149.0233.5
	Ø 1.4-1.6	149.0229.5	-

## Wear parts for ROBO WH W500

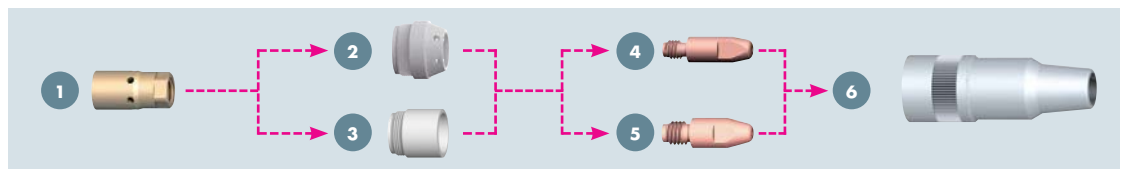

### 1 Contact tip holder (10 pcs.)

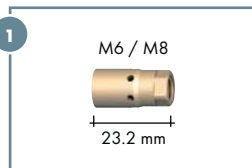

Type	Part-No.
M6 Copper <sup>1</sup>	142.0133.10
M6 Brass	142.0216.10
M8 Copper <sup>1</sup>	142.0151.10
M8 Brass	142.0117.10

<sup>1</sup> Recommended for high amperages.

### 2 Gas diffuser 3 Nozzle insulator (10 pcs.)

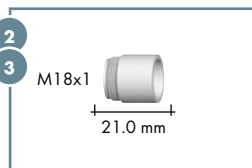

Type	Part-No.
Gas diffuser, standard (not ill.)	943.0284
Nozzle insulator, standard	146.0054.10
Nozzle insulator, standard/short	146.0064
Nozzle insulator, resistant to high temperatures	146.0059.10

### 4 Contact tip M6 5 Contact tip M8 (10 pcs.)

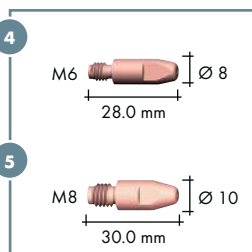

Type	Wire-Ø	Part-No.	
		M6	M8
CuCrZr	Ø 0.8	140.0054	140.0117
	Ø 0.9	140.0172	140.0217
	Ø 1.0	140.0245	140.0316
	Ø 1.2	140.0382	140.0445
	Ø 1.4	-	140.0536
	Ø 1.6	-	140.0590

### 6 Gas nozzle (10 pcs.)

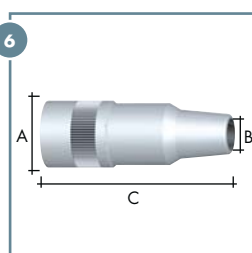

Type bottle form	Ø A	Ø B	Length C	Part-No.
Recess (-2.6 mm) <sup>2</sup>	Ø 27.0	Ø 13.0	77.0 mm	145.0556.10
Recess (-1.1 mm) <sup>2</sup>	Ø 27.0	Ø 13.0	75.5 mm	145.0479.10
Recess (-2.6 mm) <sup>2</sup>	Ø 27.0	Ø 15.5	77.0 mm	145.0480.10
Recess (-1.1 mm) <sup>2</sup>	Ø 27.0	Ø 15.5	75.5 mm	145.0544.10
Stick-out (+2.4 mm) <sup>3</sup>	Ø 27.0	Ø 15.5	72.0 mm	145.0466.10

Type conical	Ø A	Ø B	Length C	Part-No.
Recess (-1.1 mm) <sup>2</sup>	Ø 27.0	Ø 15.5	75.5 mm	145.0553.10
Stick-out (+2.4 mm) <sup>3</sup>	Ø 27.0	Ø 15.5	72.5 mm	145.0568.10

<sup>2</sup> Recess: Contact tip recessed

<sup>3</sup> Stick-out: Contact tip protruding

# "ROBO WH & WH-PP" liquid cooled Torch Necks & Wear Parts

## ROBO WH W600



### Torch neck

Features	Part-No.			
	0°	22°	35°	45°
Standard	962.1745.1	962.1746.1	962.1747.1	962.1748.1
with gas nozzle sensor*	962.1769.1	962.1770.1	962.1771.1	962.1772.1

Wear parts and fittings are not included in the scope of delivery! Please order these separately and according to the application!

\* Gas nozzle sensor connection for tactile seam location via gas nozzle

### Neck-liner

for	Wire-Ø	Part-No.
Steel	Ø 1.0-1.2	149.0270.5
	Ø 1.4-1.6	149.0271.5
Aluminium	Ø 1.2-1.6	149.0272.5

## Wear parts for ROBO WH W600

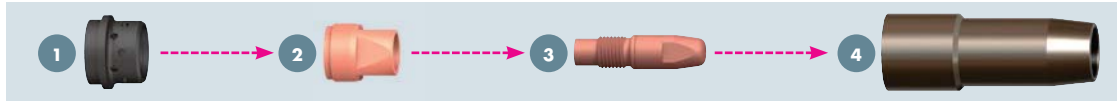

### 1 Gas diffuser (10 pcs.)



Type	Part-No.
Standard	146.0079.10

### 2 Contact tip holder (10 pcs.)

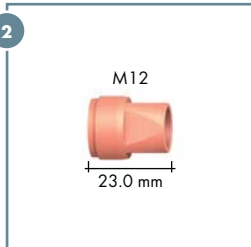

Type	Part-No.
M12	142.0214.10

### 3 Contact tip (10 pcs.)

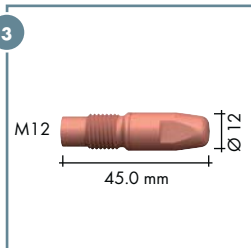

Type	Wire-Ø	Part-No.
CuCrZr	Ø 1.2	140.1563.10
	Ø 1.4	140.1564.10
	Ø 1.6	140.1565.10
HDS**	Ø 1.2	147.6563.10
	Ø 1.4	147.6564.10
	Ø 1.6	147.6565.10

\*\*HDS = Heavy Duty Silver Contact Tips

### 4 Gas nozzle (5 pcs.)

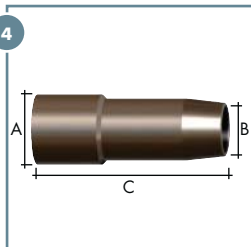

Type conical	Ø A	Ø B	Length C	Part-No.
Flush <sup>1</sup>	34.0	21.5	92.0 mm	145.0686.5
Stick-Out (+ 6.0 mm) <sup>2</sup>	34.0	21.5	86.0 mm	145.0687.5
Recess (- 3.0 mm) <sup>3</sup>	34.0	21.5	95.0 mm	145.0688.5
Flush <sup>1</sup>	34.0	18.0	92.0 mm	145.0689.5

<sup>1</sup> Flush: Contact tip flush

<sup>2</sup> Stick-out: Contact tip protruding

<sup>3</sup> Recess: Contact tip recessed

# "ROBO WH & WH-PP" liquid cooled Cable Assemblies & Accessories

## Cable assemblies and connection types

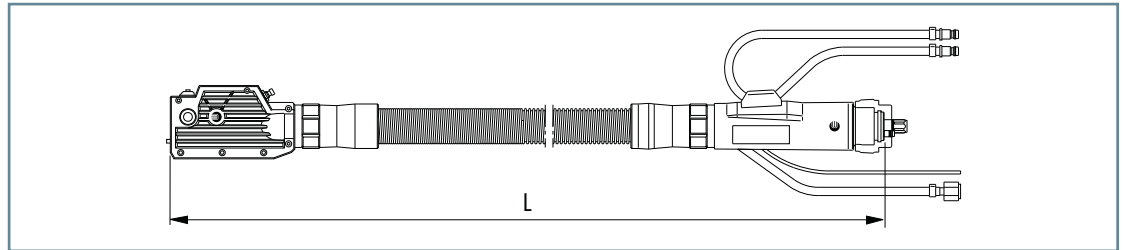

### Cable assemblies "WH" cpl.

with connection type	Length	Part-No.
ABICOR BINZEL®	1.05 m	965.2001
Euro central connection	1.15 m	965.2002
	1.25 m	965.2003
	1.45 m	965.2004
	1.65 m	965.2005
	2.15 m	965.2006
	2.65 m	965.2007
	3.15 m	965.2008

### Cable assemblies "WH-PP" cpl.

(Gear ratio  $i=17.1:1$  / Motor 42 V DC\*)

with connection type	Length	Part-No.
ABICOR BINZEL®	1.10 m	965.4014
Euro central connection	1.50 m	965.4015
	1.70 m	965.4016
	2.20 m	965.4001
	2.70 m	965.4002
	3.20 m	965.4003

The red steel liner 0.8 - 1.2 mm is included in the scope of delivery. Please order other versions separately.

\*The control cable is not configured at the machine end. Power source specific versions of the motor-gear combination (24 V / 42 V / 32 V) as well as lengths greater than 3.2 m on request.

## Liners for Euro central connection<sup>1</sup>

Type	Wire-Ø	up to L=1.65 m	up to L=3.20 m	up to L=5.00 m
Liner steel red <sup>2</sup>	Ø 0.8 - 1.2	124.0176	124.0111.1	124.0113.1
Liner steel BSLblue <sup>2</sup>	Ø 1.4 - 1.6	124.0136	124.0108	124.0110
PA-liner <sup>3</sup>	Ø 0.8 - 1.2	128.0039	128.0012	128.0016
	Ø 1.4 - 1.6	128.0040	128.0020	128.0030

<sup>1</sup> Liners for other connection types are available on request

<sup>2</sup> Red and BSLblue steel liners (insulated) for the use of non-alloyed and low-alloyed steels. The totally insulated wire feed prevents damage caused by "micro-arcing" on the wire. This allows optimal current transfer inside the contact tube, improving the welding process. The insulated steel liner must always be used for power sources with optimal welding wire sensors. Liners for aluminium and special wires on request.

<sup>3</sup> PA-liners for the use of aluminium and special wires. Good gliding properties and abrasion resistance. Application temperature limit 150°C.

## Drive rolls for WH-PP

Wire-Ø	Aluminium (U-groove)	Universal (V-groove)
Ø 0.8	961.0017	961.0269
Ø 0.9	961.0056	961.0270
Ø 1.0	961.0018	961.0227
Ø 1.2	961.0019	961.0228
Ø 1.4	-	961.0279
Ø 1.6	961.0020	961.0267

## Accessories



### Alignment jig

for torch type	Torch geometry	Part-No.
ROBO WH W300	45°	837.0163.1
ROBO WH W500	0° / 22° / 35° / 45°	837.0020.1
ROBO WH W600	0° / 22° / 35° / 45°	837.0846.1

# “ROBO WH & WH-PP” liquid cooled Holder & TCP Geometries

## Torch holder for ROBO WH and WH-PP

in connection with CAT3 cpl.

Torch type	Torch geometry	X	Y	h	$\alpha$	Part-No.
		(mm)				
ROBO WH W300	45°	396	0	95	52°	960.0026.1
ROBO WH W500	0°	370	0	80	23°	960.0026.1
	22°	354	0	89	35°	960.0026.1
	35°	362	0	96	41°	960.0026.1
	45°	349	0	99	46°	960.0026.1
ROBO WH W600	0°	426	0	84	19°	960.0026.1
	22°	410	0	93	32°	960.0026.1
	35°	395	0	98	38°	960.0026.1
	45°	382	0	102	43°	960.0026.1

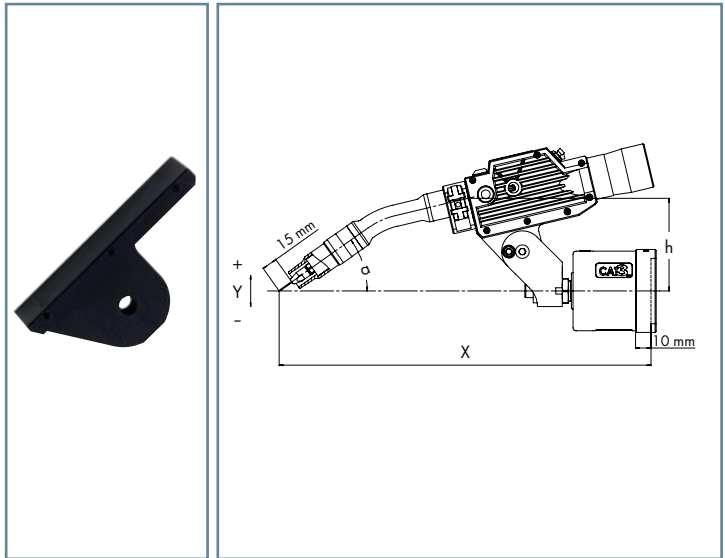

## Segment holder for ROBO WH and WH-PP<sup>1</sup>

in connection with CAT3

Torch type	Torch geometry	X	Y	h	$\alpha$	Part-No.
		(mm)				
ROBO WH W300	45°	399	35	100	45°	780.0307.1
ROBO WH W500	0°	365	100	100	0°	780.0307.1
	22°	356	55	100	22°	780.0307.1
	35°	364	26	100	35°	780.0307.1
	45°	350	3	100	45°	780.0307.1
ROBO WH W600	0°	422	100	100	0°	780.0307.1
	22°	412	49	100	22°	780.0307.1
	35°	397	15	100	35°	780.0307.1
	45°	380	-11	100	45°	780.0307.1

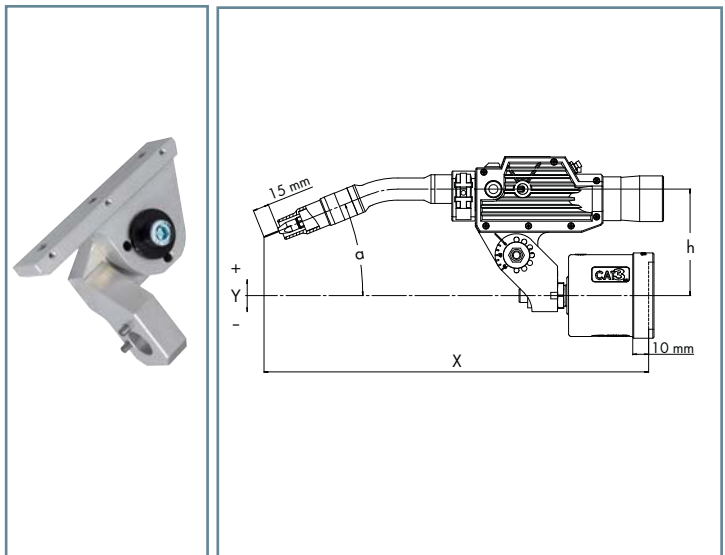

## RTM holder for ROBO WH and WH-PP<sup>1</sup>

for robots with collision software

Torch type	Torch geometry	X	Y	h	$\alpha$	Part-No.
		(mm)				
ROBO WH W300	45°	356	-36	127	71°	780.0360
ROBO WH W500	0°	354	37	127	26°	780.0360
	22°	327	0	127	48°	780.0360
	35°	321	-30	127	61°	780.0360
	45°	288	-44	127	71°	780.0360
ROBO WH W600	0°	405	12	127	26°	780.0360
	22°	374	-30	127	48°	780.0360
	35°	346	-54	127	61°	780.0360
	45°	319	-70	127	71°	780.0360

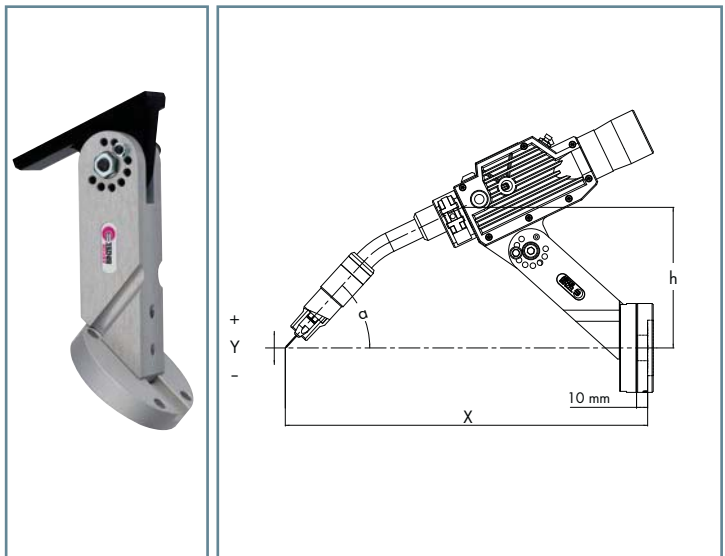

Further holders are available on request.

<sup>1</sup> Holder adjustable in 15° steps.